

# PRODUKTE FÜR MOBILES WOHNEN

ITEMS FOR MOBILE LIVING



2451 Taster & Rosette / push button & rosette



Bestellnummer | Order no.

- 01 Taster / push button  
2451-26ZN1  
2451-26ZN21  
2451-26ZNS25
- 02 Rosette / rosette  
2451-40ZN1  
2451-40ZN21  
2451-40ZNS25

Holzstärke: 15 - 17mm! Thickness of wood: 15 - 17mm!

Druckguss / die cast



passend zu Schloss H238 /  
matching to lock H238

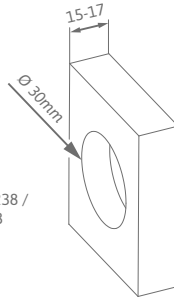

∅	D	H
01	26	27
02	40	23

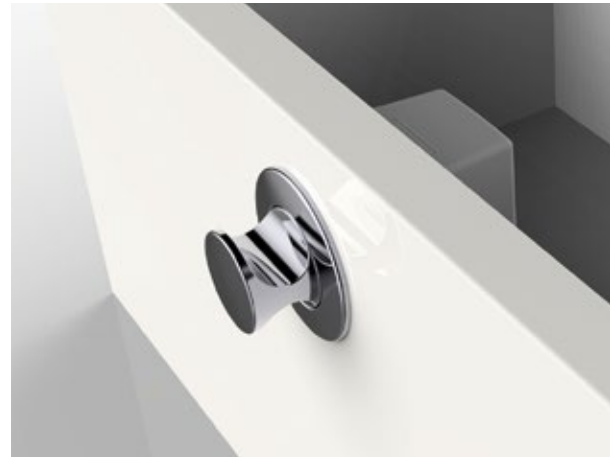

01111 Taster & Rosette / push button & rosette



Bestellnummer | Order no.

- 01 Taster / push button  
01111-26E4  
01111-26G1  
01111-26MTS5
- 02 Rosette / rosette  
01111-40E4  
01111-40G1  
01111-40MTS5

Holzstärke: 15 - 17mm! Thickness of wood: 15 - 17mm!  
Senkrechte Montage erforderlich! Vertical mounting required!

Kunststoff / plastic



passend zu Schloss H238 /  
matching to lock H238

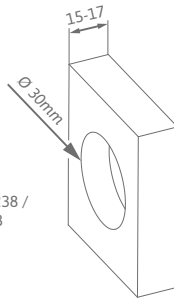

∅	D	H
01	26	26
02	40	23



H238 Schloss / lock



Bestellnummer | Order no.  
H238-58A148

Kunststoff / plastic



A148

passend zu Taster & Rosette 2451 und 01111 /  
matching to push button & rosette 2451 and 01111

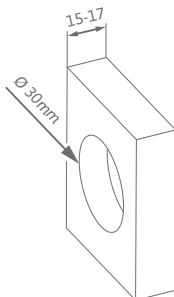

↔	↗	↑	↔↔
L	B/W	H	LA/CC
58	46	46	44





Bestellnummer | Order no.  
 2352-58PB21A139  
 2352-58ZN1A139  
 2352-58ZN16A139  
 2352-58ZN21A139

Druckguss - Kunststoff / die cast - plastic

Rastet beim Verschießen automatisch ein.  
 Einfaches Öffnen durch das Betätigen des Verriegelungshebels.  
 Snaps automatically by locking.  
 Easily to open by pressing the locking lever.

L	B/W	H	LA/CC
58	44	34	32

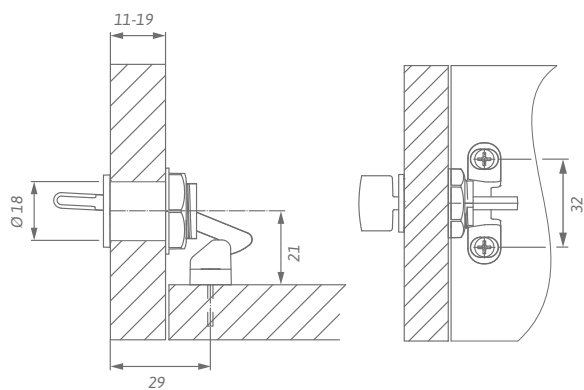

PB21A139



ZN1A139



ZN16A139

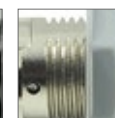

ZN21A139

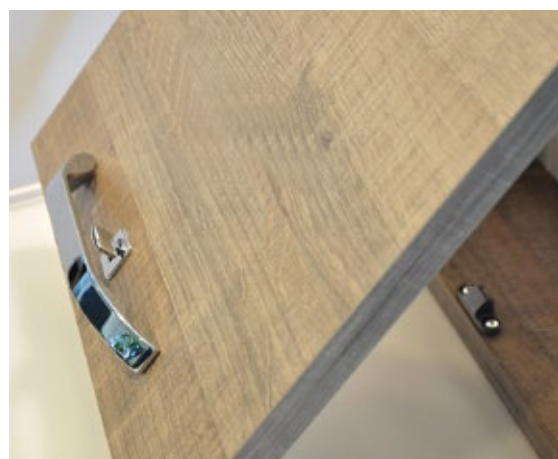

01094 Storage Box



Bestellnummer | Order no.  
 01094-90K39K1V2\*  
 01094-90RP85MV1V2\*  
 01094-160K39K1V2\*  
 01094-160RP85MV1V2\*  
 01094-250K39K1V2\*  
 01094-250RP85MV1V2\*

\* Bestellnr. für 2 Stück /  
 order no. for 2 pcs.  
 VE / MOQ : 1 = 2 Stück / pieces

Kunststoff / plastic

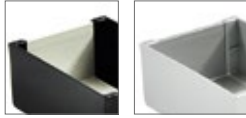

K39K1

RP85MV11

L	B/W	H
90	127	56
160	127	56
250	127	56



H215 Clip für Storage Box / clip for storage box



Bestellnummer | Order no.  
 H215-56K27  
 H215-56K39

Für die Wandmontage empfehlen wir 2 Montage Clips! /  
 For wall mounting we recommend two mounting clips!

Kunststoff / plastic

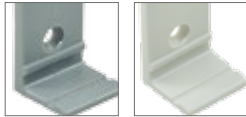

K27

K39

L	B/W	H	LA/CC
56	25	23	28



# STORAGE BOX

Aufbewahrungssystem



Belastungsgewicht: max. 2 kg /  
 loading weight: max. 2 kg



2479



Bestellnummer | Order no.  
2479/ZN1A3  
2479/ZN1A4



Druckguss - Kunststoff / die cast - plastic

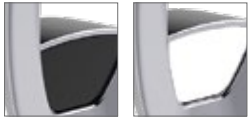

ZN1A3

ZN1A4

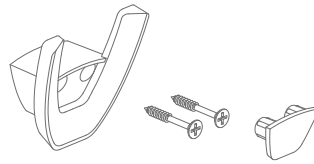

L 49	B/W 49	H 31	LA/CC 14,5

2478



Bestellnummer | Order no.  
2478/ZN1A3  
2478/ZN1A4

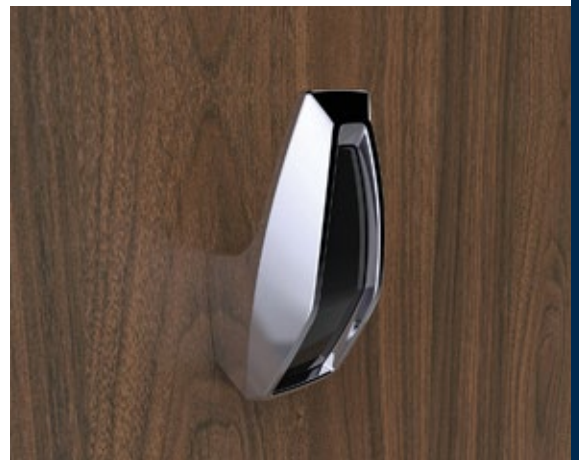

Druckguss - Kunststoff / die cast - plastic



ZN1A3

ZN1A4

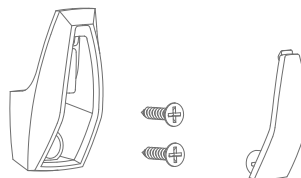

L 49	B/W 23	H 27	LA/CC 12



Abbildung: 2479/ZN1A3

**SYSTEM WAVE**

2367 Montagestange mit Endkappen / mounting rail with end caps



Bestellnummer | Order no.  
2367-500ZN1G1

Schiene kann waagrecht und senkrecht montiert werden.  
Rail can be mounted horizontally and vertically.

Aluminium - Kunststoff / aluminium - plastic



G1 / ZN1

L	B/W	H	LA/CC
500	30	10	435



**SYSTEM WAVE**

2368 Montageclip mit Kunststoffschraube / mounting clip



Bestellnummer | Order no.  
2368-36ZN1A4

Montageteil kann an beliebiger Position auf der Schiene festgeklemmt werden.  
Mounting part can be clamped in any position on the rail.

Druckguss - Kunststoff / die cast - plastic



ZN1A4

L	B/W	H
36	20	13



## SYSTEM WAVE

H228 Schale hoch / high tray



Bestellnummer | Order no.  
H228-109A3  
H228-109A4  
H228-109A138

Kunststoff / plastic



A3

A4

A138

Kann auf senkrecht und waagrecht montierter Schiene befestigt werden.  
Can be mounted on vertically and horizontally placed rail.

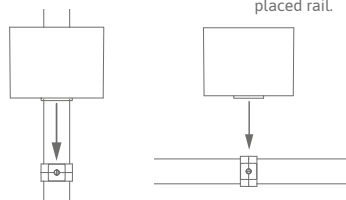

L 109  
B/W 42  
H 85



## SYSTEM WAVE

H229 Schale flach / shallow tray



Bestellnummer | Order no.  
H229-194A3  
H229-194A4  
H229-194A138

Kunststoff / plastic



A3

A4

A138

Kann auf senkrecht und waagrecht montierter Schiene befestigt werden.  
Can be mounted on vertically and horizontally placed rail.

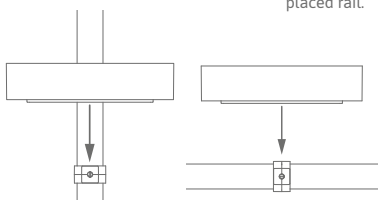

L 194  
B/W 87  
H 45



## SYSTEM WAVE

H230 Montageclip für H228 und H229 / mounting clip für H228 and H229



Bestellnummer | Order no.  
H230-44A3  
H230-44A4  
H230-44A138  
H230-44G1

Kunststoff / plastic



A3

A4

A138

G1

Für die Montage ohne Schiene.  
For mounting without rail.

L 44  
B/W 20  
H 6  
LA/CC 32



2375 Toilettenpapierhalter / toilet paper holder  
linke Version / left version



Bestellnummer | Order no.  
2375/ZN1G1A141

Stahl - Kunststoff / steel - plastic



ZN1G1A141

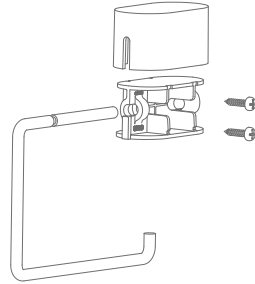

L	B/W	H	LA/CC
100	121	31	16



2405 Toilettenpapierhalter / toilet paper holder  
rechte Version / right version



Bestellnummer | Order no.  
2405/ZN1G1A141

Stahl - Kunststoff / steel - plastic



ZN1G1A141

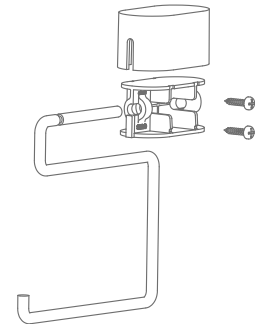

L	B/W	H	LA/CC
127	121	31	16



2456 Toilettenpapierhalter / toilet paper holder  
links und rechts verwendbar / usable on the left and right side



Bestellnummer | Order no.  
2456/ZN1G1A141

Stahl - Kunststoff / steel - plastic



ZN1G1A141

**matching accessoires:**  
passend zu 2469, 2475 und 2476 /  
matching to 2469, 2475 and 2476

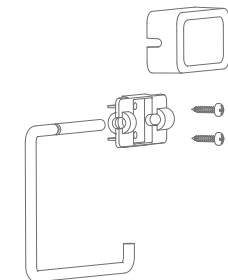

L	B/W	H	LA/CC
121	100	17	16





2469

Handtuchhalter / towel holder  
links und rechts verwendbar / usable on the left and right side



Bestellnummer | Order no.  
2469/ZN1G1A141

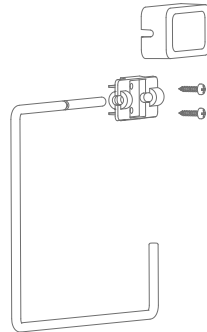

Stahl - Kunststoff / steel - plastic



**matching accessories:**  
passend zu 2456, 2475 und 2476 /  
matching to 2456, 2475 and 2476

ZN1G1A141

			
L	B/W	H	LA/CC
164	200	17	16



2475 + 0723 Becherhalter mit tiefem Becher / cup holder with deep cup



Bestellnummer | Order no.  
 01 2475/ZN1G1  
 02 0723-114KM1



Druckguss - Kunststoff / die cast - plastic



ZN1G1

KM1

passend zu  
 2456, 2469 und 2476 /  
 matching to  
 2456, 2469 and 2476

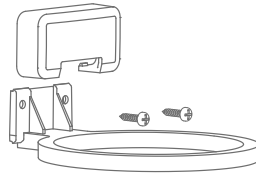

	L	B/W	H	LA/CC
01	136	114	34	32
02	114	114	105	

2475 + 0726 Becherhalter mit Seifentasse / cup holder with soap cup



Bestellnummer | Order no.  
 01 2475/ZN1G1  
 02 0726-114KM1



Druckguss - Kunststoff / die cast - plastic



ZN1G1

KM1

passend zu  
 2456, 2469 und 2476 /  
 matching to  
 2456, 2469 and 2476

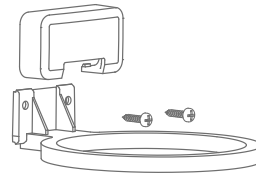

	L	B/W	H	LA/CC
01	136	114	34	32
02	114	114	33	

2476 + 0714 Becherhalter mit Becher / cup holder with cup



Bestellnummer | Order no.  
 01 2476/ZN1G1  
 02 0714-72KM1



Druckguss - Kunststoff / die cast - plastic



ZN1G1

KM1

passend zu  
 2456, 2469 und 2476 /  
 matching to  
 2456, 2469 and 2476

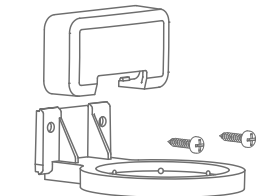

	L	B/W	H	LA/CC
01	90	70	34	32
02	72	72	80	



Bestellnummer | Order no.  
 01 2346-348ZN1G  
 02 H246-306A3



Druckguss - Kunststoff / die cast - plastic



ZN1A3

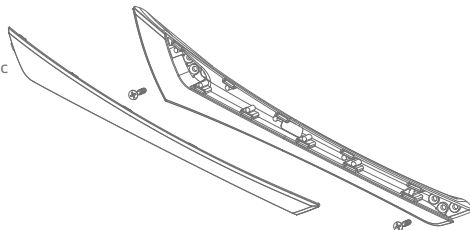

	L	B/W	H	LA/CC
01	348	61	57	228/249/267
02	306	30	45	

AUSFÜHRUNGSBEZEICHNUNG / COLOUR CODE

Kunststoff

A3	schwarz / black
A4	weiß / white
A138	anthrazit / anthracite
A139	grau / grey
A141	silbergrau / silver grey
A148	signal grau / signal grey
E4	Edelstahleffekt / stainless steel effect
G1	Chrom glänzend / bright chrome
K1	schwarz / black
K27	silbergrau / silver grey

K39	hellgrau / light grey
KM1	natur transluzent / natural translucent
MTS5	Schwarzchrom glänzend / bright black chrome
MV11	Aluminium / aluminium
RP85	Aluminium / aluminium

Metall

ZN1	Chrom glänzend / bright chrome
ZN16	Schwarzchrom glänzend / bright black chrome
ZN21	Edelstahleffekt / stainless steel effect
ZNS25	Schwarzchrom / black chrome



# PRODUKTE FÜR MOBILES WOHNEN

ITEMS FOR MOBILE LIVING

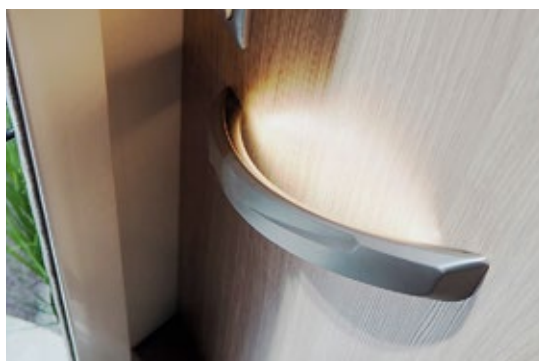

Entdecken Sie das gesamte SIRO Produktuniversum auf:  
Discover the entire SIRO product universe on:

[www.siro.at](http://www.siro.at)

SIRO Beschläge- und Metallwarenfabrik Ges. m. b. H.  
Spielfeldstraße 12 / 4452 Ternberg / Austria  
Tel: +43 (0) 7256.6020.0 / Fax: +43 (0) 7256.8932  
E-Mail: [office@siro.at](mailto:office@siro.at)

 **SIRO**  
FASHION FOR FURNITURE